

COXO[®]
www.coxotec.com



Foshan COXO Medical Instrument Co.,Ltd

BLDG 4,District A,Guangdong New Light Source Industrial Base,
South of Luocun Avenue,Nanhai District,Foshan, 528226 Guangdong,China.



Wellkang Ltd.

SuiteB,29 Harely Street,London W1G9QR, United Kingdom.

Ver1.1 20180514

COXO[®]

Dental Implant System
C-Sailor **PRO**
Operation Manual **EN**



CE 0197

15.4 Recommended safe distance between portable and mobile HF telecommunications equipment and the Device

The Device is designed for operation in an electromagnetic environment like the one described below. The customer or user of the Device can help prevent electromagnetic interference by keeping the minimum safe distance between portable and mobile HF telecommunication devices (transmitters) and the device depending on the output cable of the communication device - as given be low.

Rated power of the transmitter in W	150kHz to 80 MHz $d=1.17\sqrt{P}$	80 MHz to 800 MHz $d=1.17\sqrt{P}$	800 MHz to 2.5 GHz $d=2.33\sqrt{P}$
0.01	0.12	0.12	0.23
0.1	0.37	0.37	0.74
1	1.17	1.17	2.33
10	3.70	3.70	7.37
100	11.70	11.70	23.30

For transmitters whose maximum rated power is not included in the above table, the recommended safe distance d in meters (m) can be calculated using the equation for the respective column, where P is the maximum rated power of the transmitter in Watts (W) as specified by the manufacturer.

Note 2: These guidelines may not be applicable in every case. The spread of electromagnetic waves is absorbed and reflected by buildings, objects and people.

Comment 1: To calculate the recommended safe distance from transmitters with a frequency range of 80 MHz to 2.5 GHz, an additional factor of 10/3 was used to reduce the probability that a mobile/portable communication unit that is inadvertently brought into the patient area would cause malfunction.

Contents

1.	Precautions	01
1.1	Symbol	01
1.2	Definition of safety warning signs	02
1.3	Safety instructions	02
1.4	Information about electromagnetic compatibility	04
2.	Intended Use	05
3.	Contraindications	05
4.	Structure	06
4.1	Front panel	06
4.2	Rear panel	06
4.3	Foot control	07
4.4	Surgical motor	07
5.	Installation	08
5.1	Installing the stand	08
5.2	Plugging in the foot control	08
5.3	Connecting the surgical motor	09
5.4	Attaching the straight or contra-angle handpiece	10
5.5	Removing the straight or contra-angle handpiece	10
5.6	Connecting the irrigation tubing set	11
5.7	Electrical connection	12
6.	Operation	13
6.1	Preparation	13
6.2	Program	13
6.3	Setting	16
6.4	Changing default values	18
6.5	Operation	21
6.6	Factory settings	24
6.7	Calibration	25
7.	Maintenance of Medical Devices	26
7.1	Fuse Replacement	26
7.2	LED Replacement	27
7.3	Exchanging the O-rings	28
8.	Troubleshooting	29
9.	Disposal of Medical Devices	30

- 10. Cleaning, Disinfection and Sterilization ----- 31
 - 10.1 Cleaning ----- 31
 - 10.2 Disinfection ----- 31
 - 10.3 Thermo disinfection ----- 31
 - 10.4 Drying ----- 32
 - 10.5 Packaging ----- 32
 - 10.6 Sterilization ----- 32
 - 10.7 Storage ----- 33
- 11. After-sales service ----- 34
 - 11.1 Terms and conditions of warranty ----- 34
 - 11.2 Disclaimer ----- 34
- 12. Operating environment and transport, storage conditions ----- 35
 - 12.1 Operating environment ----- 35
 - 12.2 Transportation and storage conditions ----- 35
- 13. Technical Description ----- 36
- 14. Package Contents ----- 37
- 15. Details on electromagnetic compatibility ----- 38
 - 15.1 Guidelines and manufacturer's declaration-
electromagnetic transmission ----- 38
 - 15.2 Guidelines and manufacturer's declaration-
electromagnetic resistance to jamming ----- 39
 - 15.3 Guidelines and manufacturer's declaration-
electromagnetic resistance to jamming ----- 40
 - 15.4 Recommended safe distance between portable and mobile
HF telecommunications equipment and the Device ----- 42

Note 1: At 80 MHz and 800 MHz, the higher frequency range applies.

Note 2: These guidelines may not be applicable in every case. The propagation of electromagnetic waves is subject to absorption and reflection by buildings, objects, and people.

^aThe field strength of stationary transmitters such as base stations of mobile telephones and land mobile radio devices, amateur radio stations, AM and FM radio and television broadcasting stations cannot be determined based on theoretical considerations. A site study should be considered to determine the electromagnetic environment in terms of stationary transmitters. If the field strength measured at the site, at which the Device is used, exceeds the compliance levels shown above, the device should be monitored to demonstrate proper function. Should unusual performance features be observed, additional measures may be required, such as, e.g., a different alignment or different location for the Device.

^bIn the frequency range of 150 kHz to 80 MHz, the field strength should be less than 3Veff V/m.

15.3 Guidelines and manufacturer's declaration - electromagnetic resistance to jamming

The Device is designed for operation in an environment like the one described below. The Device customer or user should ensure that the unit is used in an environment matching the description.























Interference immunity tests	IEC 60601 test levels	Compliance level	Electromagnetic environment - Guidelines
Wire-based HF interference according to IEC61000-4-6 Wireless HF interference according to IEC61000-4-3	3 Veff 150 kHz to 80 MHz 30 V/m 80 MHz to 2.5 GHz	3 Veff 30 V/m	<p>Portable and mobile radio devices should not be used closer to the Device, including the wires, than the recommended safe distance calculated using the equation for the transmission frequency.</p> <p>Recommended safe distance: $d = [3.5/3] \sqrt{P} = 1.17 \sqrt{P}$ $d = [3.5/3] \sqrt{P} = 1.17 \sqrt{P}$ for 80 MHz to 800 MHz $d = [7.0/3] \sqrt{P} = 2.33 \sqrt{P}$ for 800 MHz to 2.5 GHz</p> <p>where P is the maximal nominal power of the transmitter in watts (W) as specified by the transmitter manufacturer and d is the recommended safe clearance in meters(m).</p> <p>The field strength of stationary wireless radio transmitters as measured locally a should be lower than the conformance level at all frequencies. b</p> <p>Interference is possible in the vicinity of devices that bear the following symbol.</p>

1. Precautions

Congratulations on your purchase of the product.

Read this operation Manual carefully before use for operating instructions, care and maintenance. Keep this manual for future reference.

1.1 Symbol

	Refer to the chapter on "Definition of safety warning signs"		Important information for users and service technicians
	Follow the instructions for use		Protected against the effect of immersion
	Thermo disinfectable		Autoclavable up to 134°C.
	Classification, type B		Temperature limit (5°~ 40°) .
	Humidity limit.		Atmospheric pressure limit.
	Avoid the sun.		Keep dry
	Vertical up.		Fragile, handle with care
	Stacking limit		This symbol is affixed to fulfill the requirements of EU Directive 2002 /92/ED Article 11.
	Serial number		Batch code
	CE mark		Catalogue number
	Authorized representative in the European Community		Operating mode: continuous operation with intermittent load

Foot control	Alternating Current
ON(Power connection)	OFF(Power disconnection)
Electric fuse	Manufacturer
Date of manufacture	

1.2 Definition of safety warning signs

	CAUTION Indicates a hazardous situation that can cause damage to property or mild to moderate injuries.
	WARNING Indicates a hazardous situation that can lead to serious or fatal injury
	DANGER Indicates a maximal hazard due to a situation that can directly cause death or fatal injury.

1.3 Safety instructions

	WARNING Use of un-authorized accessories or un-authorized modifications of the product. Accessories that have not been approved and/or inadmissible modifications of the product could lead to hazards and/or personal injury or material damage. ► Only use accessories that have been approved for the combination with the product by the manufacturer or are equipped with standardized interfaces. ► Do not make any modifications to the device unless these have been approved by the manufacturer of the product.
--	---

15.2 Guidelines and manufacturer's declaration - electromagnetic resistance to jamming

The Device is designed for operation in an environment like the one described below. The Device customer or user must ensure that the unit is used in an environment matching the description.

Interference immunity tests	IEC 60601 test levels	Compliance level	Electromagnetic environment - Guidelines
Electrostatic discharge (ESD) according to IEC61000-4-2	± 8 kV contact discharge ± 15 kV atmospheric discharge	± 8 kV contact discharge ± 15 kV atmospheric discharge	Floors should be made of wood or concrete or be fitted with ceramic tiles. If the floor is fitted with synthetic material, the relative humidity must be at least 30
Fast transient electrical interference / bursts according to IEC	± 2 kV for power lines	± 2 kV for power lines	The quality of the supply voltage should correspond to that of a typical business or hospital
Surges according to IEC 61000-4-5	± 1 kV push-pull voltage (symmetrical) ± 2 kV common	± 1 kV push-pull voltage (symmetrical) ± 2 kV common	The quality of the supply voltage should correspond to that of a typical business or hospital environment.
Voltage interruptions, short-term interruptions, and fluctuations of the supply voltage according to IEC 61000-4-11	< 5 % U _T for ½ period (> 95 % interruption) 40 % U _T for 5 periods (60 % interruption) 70 % U _T for 25	< 5 % U _T for ½ period (> 95 % interruption) 40 % U _T for 5 periods (60 % interruption) 70 % U _T for 25	The quality of the supply voltage should correspond to that of a typical business or hospital environment. If the user of the device needs uninterrupted function of the unit even when the power supply is interrupted, it is.
Magnetic field at a supply frequency (50/60 Hz) according to IEC 61000-4-8	30 A/m	30 A/m	Magnetic fields at the mains frequency should correspond to typical values in a business and hospital environment.

Note: U_T is the alternating mains voltage before the application of the test level.

15. Details on electromagnetic compatibility

15.1 Guidelines and manufacturer's declaration - electromagnetic transmission

The Device is designed for operation in an environment like the one described below. The Device customer or user must ensure that the unit is used in an environment matching the description.

Measurements of emitted interference	Conformance	Electromagnetic environment - Guidelines
HF emissions according to CISPR 11	Group 1	The Device uses HF energy for its internal functions exclusively.
HF emissions according to CISPR 11	Class B	The Device is designed for use in all facilities including residential
Emission of harmonics according to IEC 61000-3-2	Class A	The Device is designed for use in all facilities including residential
Emission of voltage fluctuations/ flicker	complies	The Device is designed for use in all facilities including residential

CAUTION

Electrical sparks in the product.
Explosion and/or fire.

- ▶ Do not use product in areas subject to an explosion hazard.
- ▶ Do not operate the product in an oxygen-enriched atmosphere.

CAUTION

Damaged mains cable / missing protective conductor.
Electrical shock.

- ▶ Check the mains cable before use. The socket outlet must have a protective contact and meet the respective national guidelines.

CAUTION

Damage by liquids.
Faults on electrical components.

- ▶ Protect openings of the product from any ingress of liquids.

CAUTION

Inadvertent penetration of liquids.
Electrical shock.

- ▶ Do not place the product in a tub-like container.
- ▶ Check the coolant containers and lines for absence of leakage. If any liquid is detected on the device, do not touch the device and disconnect the device from the mains supply without delay. Make sure that the surface of the device is completely dry before plugging the main plug back in the socket.

CAUTION

Rotating parts while the pump is operating.
Injuries.

- ▶ Do not stick anything in the pump. Turn off the device when the pump is open.

⚠ CAUTION

Risks from electromagnetic fields.
 Electromagnetic fields might interfere with the functions of implanted systems (such as pacemakers).
 ► Ask patients if they have a cardiac pacemaker or other system implanted before you start the treatment!

⚠ CAUTION

Impact of power failure.
 Failure of the voltage supply or other errors can cause the surgical motor to come to a standstill.
 ► Make sure that the power supply is working.

1.4 Information about electromagnetic compatibility

i Note

Based on IEC 60601-1-2 (DIN EN 60601-1-2) concerning the electromagnetic compatibility of electrical medical devices, we must draw your attention to the following points:

- Medical electrical devices are subject to special precautions concerning the electromagnetic compatibility and must be installed and operated in accordance with the Manufacturer assembly instructions.
- High-frequency communications devices may interfere with electrical medical devices.

i Note

Manufacturer cannot guarantee the compliance of accessories, cables, and other components not supplied by manufacturer with the EMC requirements of IEC 60601-1-2 (DIN EN 60601-1-2).

14. Package Contents

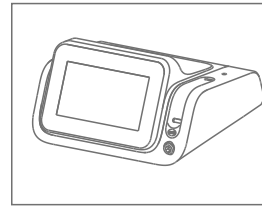

Main unit

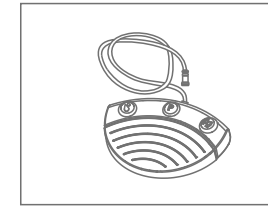

Foot Control
(With Cable)

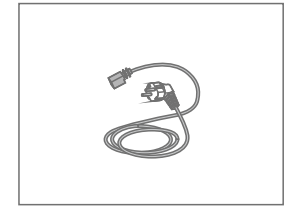

AC Electrical Cord

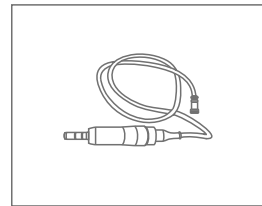

Surgical Motor
(With Cable)

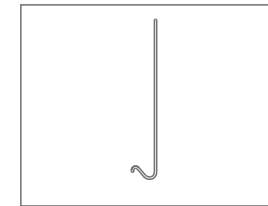

Stand

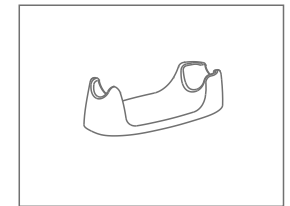

Handpiece Stand

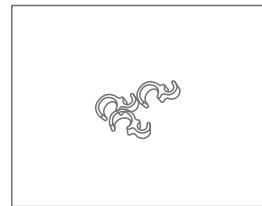

Tube Holder

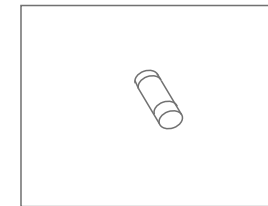

Spare Fuse

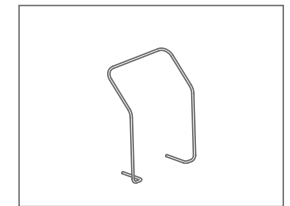

Handle(Foot control)

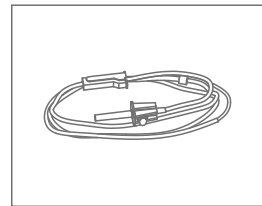

Irrigation tubing set

13. Technical Description

Main unit

Model	C-Sailor Pro
Power Supply Voltage	a.c.110/220V
Frequency	50/60Hz
Power Consumption	140VA
Dimensions	W280 x D230 x H140mm

Surgical motor

Maxima speed	40,000r/min
Maxima torque	5.5 N.cm
Input Voltage	d.c.30V

Illuminants (LED)

Type of radiation	LED
Typical color temperature	4.000 - 6.000 K
Nominal voltage of the LED	3.4 V DC
Voltage range of the LED	3.3 - 3.6 V DC
Maximal LED current	150 mA



Note

Do not exceed the specified upper voltage limit of 3.6 V DC on the LED.

2. Intended Use

- This product is intended only for use in the field of dentistry, for surgery to expose and dissect oral tissue structures or endodontic treatments (e.g. periodontal gap, gingival, bone, jaw, extractions and implantations).
- The device is intended for use by suitably qualified and trained medical, technical and specialist staff only.

3. Contraindications

- Systemic diseases (cancer, cardiovascular diseases serious diseases, the blood system, the immune system The disease, ...).
- Ongoing and topical treatment of certain systems (anticoagulant therapy, chemotherapy, radiotherapy, ...).
Poor quantity and quality of bone.

4. Structure

4.1 Front panel

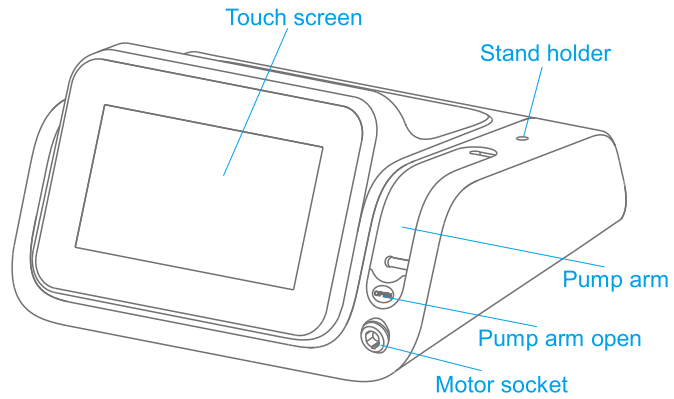

4.2 Rear panel

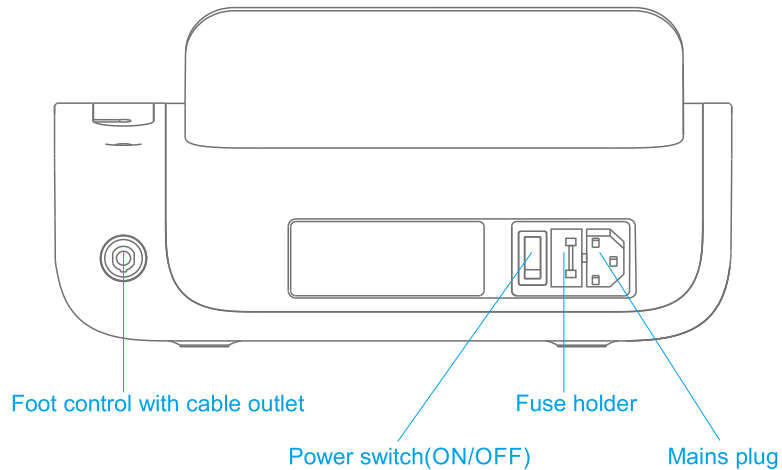

12. Operating environment and transport, storage conditions

12.1 Operating environment

⚠ WARNING

Inappropriate operating conditions.
Impairment of the electrical safety of the device.

Ambient temperature	+5 °C - +40 °C
Relative humidity	20% - 80%RH
Air pressure	860 hPa - 1060 hPa

12.2 Transportation and storage conditions

Ambient temperature	-10°C - +55°C
Relative humidity	≤93%RH
Air pressure	500 hPa - 1060 hPa

11. After-sales service

11.1 Terms and conditions of warranty

The manufacturer provides the final customer with a warranty that the product specified in the delivery note functions properly and is free of defects in the material or workmanship.

Main unit, foot control and Motor with cable warranty for 24 months from the date of purchase of the product, manufacturers provide free replacement or repair services for reasonable product defect complaints within the timeframes listed below:

Subject to the following conditions:

- ▶ Other claims of any nature whatsoever, in particular with respect to compensation, are excluded. In the event of default and gross negligence or intent, this shall only apply in the absence of mandatory legal regulations to the contrary.
- ▶ The warranty does not usually cover bulbs, glassware, rubber parts and the colorfastness of plastics.
- ▶ Claims from this warranty can only be asserted when the delivery note of the product has been sent to the manufacturer, and the original can be presented by the operator or user.

11.2 Disclaimer

The manufacture will not be responsible for accidents, unit damage, or bodily injury resulting from:

- ▶ Repairs made by personnel not authorized by the manufacture
- ▶ Any changes, modifications, or alterations of its products.
- ▶ The use of products or unit made by other manufacturers, except for those procured by the manufacture.
- ▶ Maintenance or repairs using parts or components other than those specified by the manufacture and other than in their original condition.
- ▶ Operating the unit in ways other than the operating procedures described in this manual or resulting from the safety precautions and warnings in this manual not being observed.
- ▶ Workplace conditions and environment or installation conditions which do not conform to those stated in this manual such as improper electrical power supply.
- ▶ Fires, earthquakes, floods, lightning, natural disasters, or acts of God.

4.3 Foot control

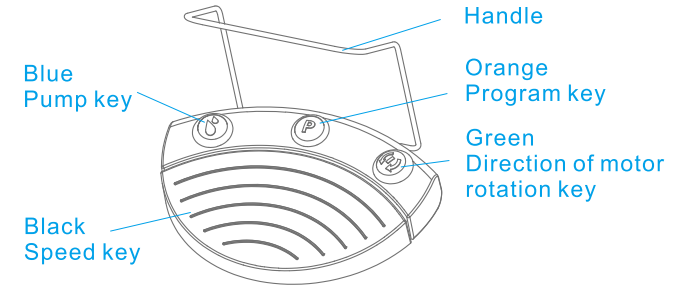

4.4 Surgical motor

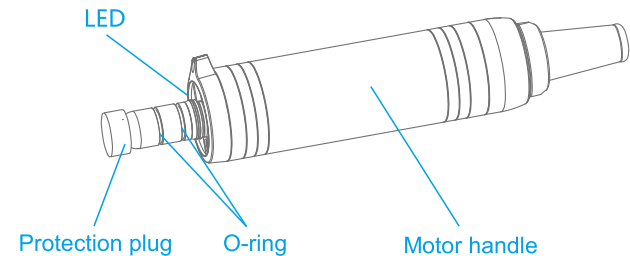

i Note

The surgical motor with cable must not be disassembled.
The surgical motor with cable must not be oiled.

5. Installation

i Note

The delivered parts are not sterile (except for the Irrigation tubing set). Before the first treatment of a patient, the surgical motor, motor cable, and the stand need to be reprocessed.

- ▶ Reprocessing steps in accordance with DIN EN ISO 17664.

5.1 Installing the stand

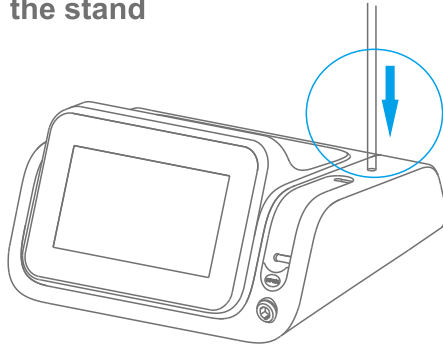

- ▶ Insert the stand, pay attention to the positioning.

5.2 Plugging in the foot control

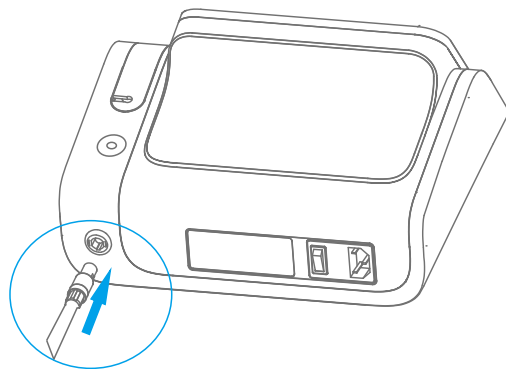

- ▶ Insert the foot controller plug into the socket on the back of the unit. Make sure that the marker arrows on the plug and the socket are aligned towards each other.

! CAUTION

Damage to device due to improper sterilization.

Damage to the sterile device.

- ▶ No hot air sterilization, no chemical cold sterilization, do not sterilize with ethylene oxide!

! CAUTION

Product damage

Contact corrosion

- ▶ Remove the sterilized item from the autoclave immediately after sterilizing and drying.

i Note

The user is responsible for observing the regulations and conditions for sterility.

The coolant container needs to be disposed and the irrigation tubing needs to be changed after each patient.

Medical devices released for sterilization are temperature-resistant up to 136 °C

 The following parts are released for sterilization:

- Motor with cable

- Stand

Autoclave with 3-fold fractionated pre-vacuum:

- At least 3 minutes at 134 °C - 1 °C/+4 °C

- Drying time: 20 min.

i Note

Allow the sterilized items to cool to room temperature before using them again.

10.7 Storage

Observe all necessary measures for hygiene when storing sterile goods. Store protected from dust and in a dry place, release with identification on the packaging.

Evaluate the duration of storage.

⚠ CAUTION

Thermo disinfection needs to include motor cables.

⚠ CAUTION

Attach the protection plug to the motor.

i Note

For detail, refer to the Thermo-disinfector's operation manual.

- ▶ In order to prevent impairment of the device, make sure that the inside and outside of the device is dry after the end of the cycle.

10.4 Drying

i Note

Irrigation tubing set with accessories is intended for single use only and is not to be disinfected and sterilized. No drying required.

- ▶ Allow all disinfected and sterilized parts to dry fully exposed to room air before using them again.

10.5 Packaging

i Note

The quality and use of the sterilization packaging must comply with applicable standards and be suitable for the sterilization procedure!

- ▶ Seal the stand and motor cable in a sterilization pouch.

10.6 Sterilization

Sterilization by moist heat in accordance with ISO 17665-1 in a steamsteriliser (autoclave)

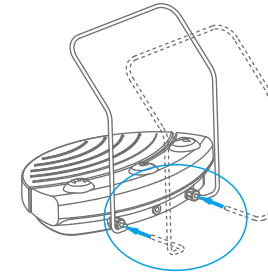

- ▶ Slide the handle into the designated recesses, and then tighten the nuts by hand.

5.3 Connecting the surgical motor

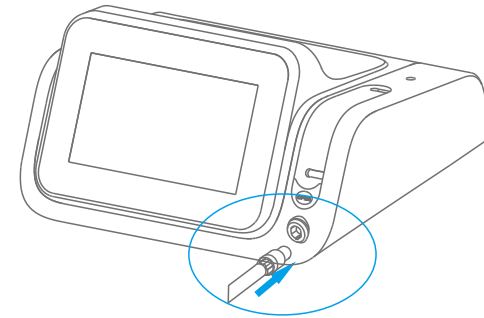

- ▶ Insert the surgical motor plug into the socket on the front of the unit. Make sure that the marker arrows on the plug and the socket are aligned towards each other.

5.4 Attaching the straight or contra-angle handpiece

CAUTION

Damage from changing the straight and contra-angle handpieces during operation.
Wear to the catch on the straight and contra-angle handpiece and motor.
Unbalanced motor axis.

- ▶ Change the straight and contra-angle handpieces only when the motor is not running.
- ▶ All ISO 3964 compliant straight and contra-angle handpieces can be attached.

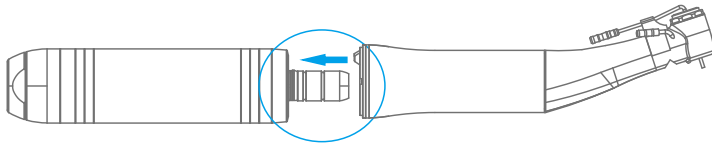

- ▶ Place the handpiece on the motor, lightly press it against the motor while turning it slightly in the direction of the arrow until the guide stud can be heard to lock into place.
- ▶ Turn on the handpiece to make sure that it is securely attached to the motor.

5.5 Removing the straight or contra-angle handpiece

CAUTION

Damage from changing the straight and contra-angle handpieces during operation.
Wear to the catch on the straight and contra-angle handpiece and motor.
Unbalanced motor axis.

- ▶ Change the straight and contra-angle handpieces only when the motor is not running.
- ▶ Pull the irrigation tubing set off the straight or contra-angle handpiece.
- ▶ Twist the straight or contra-angle handpiece slightly to pull it off.

10. Cleaning, Disinfection and Sterilization

Note

The reprocessing steps for the straight and contra-angle handpieces are described in the corresponding Instructions for use.

10.1 Cleaning

Use a moist disposable cloth to wipe down all visible surfaces of the unit, stand, foot control surfaces, and connecting cables.

10.2 Disinfection

Note

After each treatment of a patient, the surfaces near the patient that may have been contaminated by contact or aerosol need to be disinfected. All disinfection measures need to be carried out by wipe disinfection.

- ▶ Use a soft disposable cloth and an approved disinfectant for disinfection by wiping down all visible surfaces of the unit, stand, foot control surfaces, and connecting cables. Make sure that all surfaces are wetted.

10.3 Thermo disinfection

The surgical motor can be cleaned and disinfected with a Thermo-disinfector.

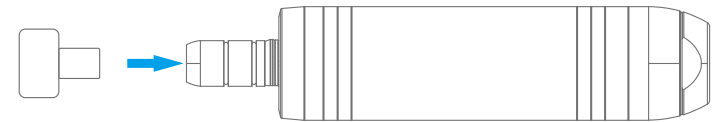

Note

Damage and corrosion, e.g. on the bearings.

- ▶ During cleaning in the thermal disinfector, protect the motor from cleaning agent ingress by means of the plug.
- ▶ Always use the protection plug during Thermo-disinfector.

No light on the straight or contra-angle handpiece.	The light is not turned on.	Turn on the light.
	The straight and contra-angle handpiece is improperly attached.	Attach the straight and contra-angle handpiece until the catch audibly locks.
	Defective LED.	Replace the LED.
	Incorrect orientation of the LED.	Change direction to reinstall
	Not a suitable straight and contra-angle handpiece.	Use a suitable light, straight and contra-angle handpiece.
Insufficient torque.	Transmission ratio set incorrectly.	Set the gear ratio to match the handpiece.
	The handpiece resistance is too large.	Recalibrate. Change the handpiece.
Over-heating.	Overheating by extended use under heavy load.	Allow it to cool down before use.
Too fast or slow.	Transmission ratio set incorrectly.	Set the gear ratio to match the handpiece.
	Need recalibrate.	Recalibrate.
E0	No motor insertion.	Insert the motor.
E1	Achieve set torque.	Release the pedal to release the torque or increase the set torque value.
E2	Calibration failed.	Check whether the contra angle is unloaded during the calibration process. If not, release the load and recalibrate. If yes, replace or lubricate, repair, etc.

9. Disposal of Medical Devices

Consult with dealer from whom you purchased it about waste disposal.

5.6 Connecting the irrigation tubing set

⚠ CAUTION
Running, open pump arm.
Risk of injury.
▶ Turn off the device before opening the pump arm.

⚠ CAUTION
Danger of tipping due to the coolant containers being too heavy.
Malfunctions.
▶ Use coolant containers with a maximal volume of 1.5 litre only.
▶ Check the stability.

i Note
The irrigation tubing set must be changed after each application.

i Note
Check the integrity of the irrigation tubing set before use. If product or packaging are damaged, the product needs to be discarded.

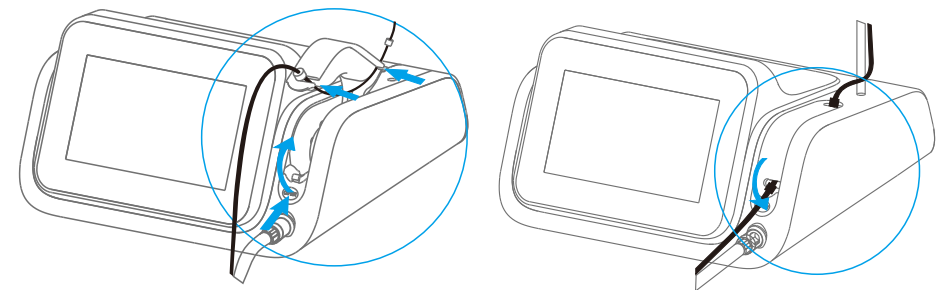

- ▶ Open the pump arm;
- ▶ Fit irrigation tubing in the direction of the graphic;
- ▶ Close the pump arm.

i Note
Follow the same sequence when removing the irrigation tubing.

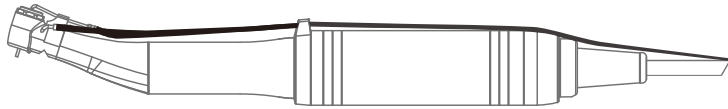

- ▶ Route the irrigation tubing set from the unit along the motor cable (clips) and connect it to the straight or contra-angle handpiece. Place the irrigation tubing set into the holding ring for this purpose.
- ▶ Place the irrigation tubing tightly, without loops or kinks, against the outside of the motor cable and attach it in regular intervals using the enclosed clips.

i Note

Make sure to place the irrigation tubing in the pump appropriately such that the tubing does not get clamped or pinched by the lock. Route all tubing relaxed and without tension.

5.7 Electrical connection

⚠ CAUTION

Damaged mains cable / missing protective conductor.
Electrical shock.

- ▶ Check the mains cable before use. The socket outlet must have a protective contact and meet the respective national guidelines.

i Note

The protective earth conductor is used as functional earthing (FE) rather than as protective earthing (PE).

- ▶ Plug the mains cable first into the mains plug on the device and then the other end of the mains cable into the electrical outlet of the supply mains.

8. Troubleshooting

i Note

If malfunctions cannot be located or eliminated using this troubleshooting guide, a technician trained by manufacturer must be commissioned to eliminate the problem.

Malfunction	Cause	Remedy
Non-functional device.	The unit is switched off.	Switch-on the mains switch on the rear of the unit.
	Neither end of the power cable is plugged in.	Plug in the power input cable.
	Blown fuse.	Replace the fuse.
The motor does not run.	Foot control connection is loose.	Check connection.
	Motor connection is loose.	Check connection.
	Overload.	Check handpiece if it stuck.
	Rinsing function is selected.	Select the other program.
No coolant in the handpiece.	No coolant flow pre-selected. Pump is off.	Pre-select coolant flow.
	Irrigation tubing clamp is closed.	Open the irrigation tubing clamp.
	Pump arm is not closed.	Check and close the pump arm.
	Irrigation tubing is kinked.	Check irrigation tubing.
Insufficient coolant flow in the instrument.	Spray nozzles are crusty or soiled.	Clean the spray nozzles with the nozzle needle or re-process the part.
The motor makes a grinding noise or does not run smoothly.	The motor is not correctly plugged on or screwed on.	Check if all the connections and couplings are firmly seated.
LED lamp is faint.	The voltage on the unit is lower.	Increase the voltage on the unit until the desired light intensity is reached.

7.3 Exchanging the O-rings

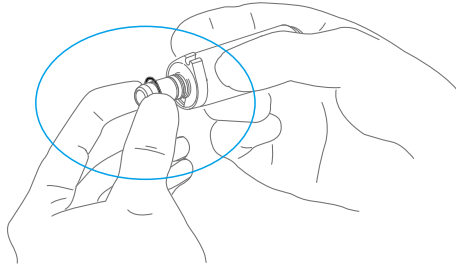

- ▶ Press the O-ring between your fingers to form a loop;
- ▶ Push the O-ring to the front, and remove it;
- ▶ Insert new O-rings into the grooves.

CAUTION

Vaseline, oils or other greases.
This can cause malfunctions.

- ▶ Do not use Vaseline, oils or other greases on this medical device.

Note

On incidence of vibration between the instrument and motor, replace the 2 O-rings.

6. Operation

6.1 Preparation

6.1.1 Switching the device on

- ▶ Turn the device on. The device runs a self test.

Note

Unless the unit is monitored, please turning it off for safety and energy saving reasons.

6.1.2 touch screen

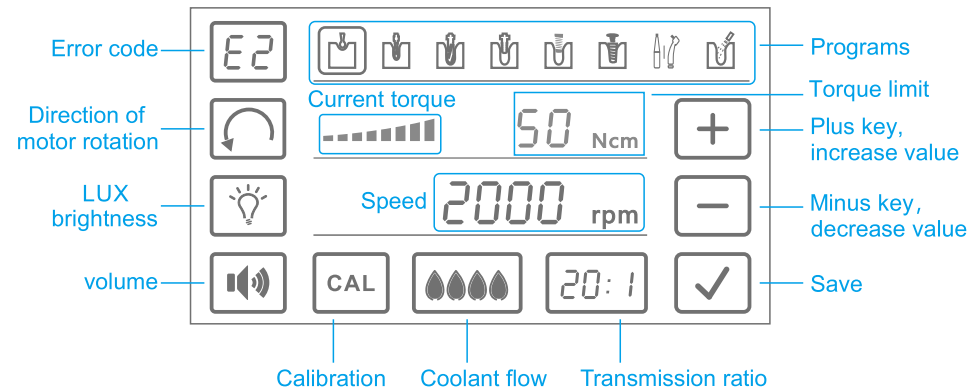

6.2 Program

Common programs are displayed in the form of icons, there are 8 programs. Visualizing the activity is an easy means for checking if the activity set on the device is the same as the current treatment program. Maloperation can thus be largely prevented.

6.2.1 Select the programs

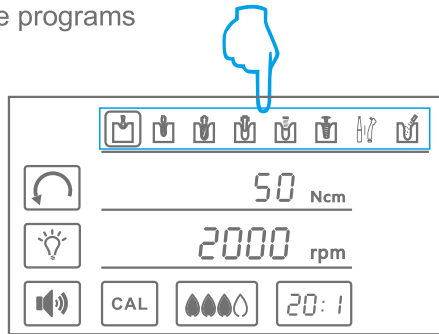

- ▶ Select program by touching the screen.
- ▶ The programs can be selected during the treatment using the program key of the foot control, after the last program follows the first program again.

6.2.2 Description of the program

Icon	Activity	Description
	Marking	Use a small round bur to make a divot in the bone
	Pilot drilling	Nitial orientation of the bone drill
	Template drilling	Prepare to the required size and depth
	Thread cutting	Create threads in the bone that match the implant
	Placing implant	Insert the dental implant into the jawbone
	Setting closure cap	Screw the healing cap onto the dental implant
	Free use	Set different parameters In addition to the planting procedure, it can be used as a dental treatment such as surgery or polishing
	Rinsing function	Feed liquid and to start up the illumination on the handpiece. The motor is not activated during this process.

7.2 LED Replacement

CAUTION

Danger due to hot bulb.
Burning hazard.

▶ Do not touch the bulb after it has been used. Let the lamp cool off.

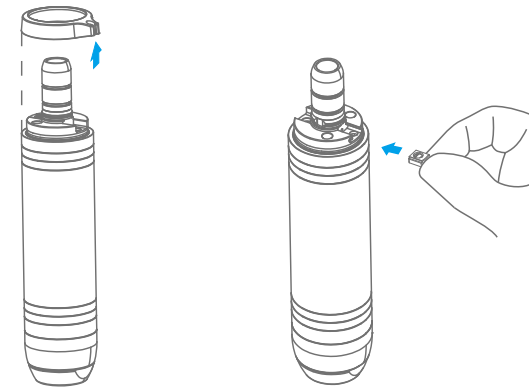

- ▶ Pull the retention ring off while twisting slightly;
- ▶ Push the old LED lamp out of the mount with your fingernail and remove it;
- ▶ Inset the new LED lamp into the recess such that the contact surface corresponds to that of the mount. Slide the lamp into the mount. Place the retention ring on the motor and pull up;
- ▶ Put the retention ring on while twisting slightly.

Note

The LED lamp is a semiconductor element and must be operated with direct current only. The lamp must be inserted with the poles in the correct orientation for the lamp to work properly.

Case1: LED lamp is faint

- ▶ Increase the voltage on the unit until the desired light intensity is reached.

Case2: LED lamp is red or off

- ▶ Insert LED lamp after rotating it 180° about its axis.

7. Maintenance of Medical Devices

7.1 Fuse Replacement

i Note

If the main unit does not function, check the fuses (Fuse box lock located on the rear of the main unit).

- To access the Fuse, use a pointed tool push on the fuse locking latch and the drawer will spring open.

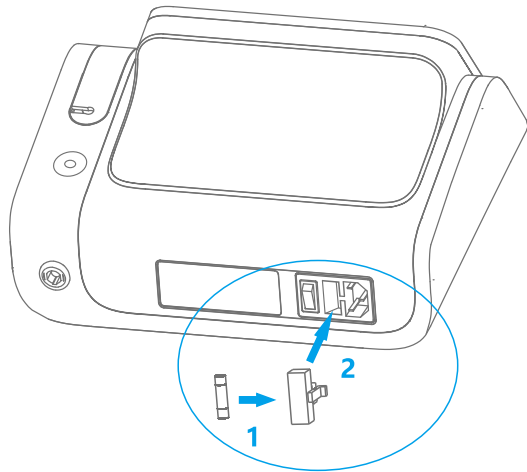

Fuse Ratings	
230V	F3AL 250V

6.2.3 Factory settings

Default values have been set at the factory for the parameters, speeds, torques, transmission ratios and coolant flow rate for every activity according to application.

The parameters can be changed only within a reasonable range for the specific activity.

The table below lists the ranges of values and factory settings.

Icon	Activity	Speed [rpm]	Torque [Ncm]	Transmission ratio	Coolant flow
	Marking	200-2500 500(D)	5-20 10(D)	16:1,20:1, 64:1,20:1(D)	0-4 2(D)
	Pilot drilling	200-2500 500(D)	5-20 10(D)	16:1,20:1, 64:1,20:1(D)	0-4 2(D)
	Template drilling	200-2500 500(D)	5-20 10(D)	16:1,20:1, 64:1,20:1(D)	0-4 2(D)
	Thread cutting	20-100 50(D)	5-80 25(D)	16:1,20:1, 64:1,20:1(D)	0-4 2(D)
	Placing implant	20-100 50(D)	5-80 25(D)	16:1,20:1, 64:1,20:1(D)	0-4 0(D)
	Setting closure cap	20-100 50(D)	5-15 10(D)	16:1,20:1, 64:1,20:1(D)	0-4 0(D)
	Free use	15-40000	5-80	1:11:5,4:1,10:1, 16:1,20:1,64:1	0-4
	Rinsing function	--	--	--	1-4

(D) =Factory setting (Default setup)

i

The range of speeds and torques that can be changed depends on the transmission ratio of handpiece ;

- The listed indications are only examples. In order to prevent risks, it is essential to comply with the manufacturer recommendations concerning implants, handpieces, and tools.

6.3 Setting

6.3.1 The following device settings can be made or displayed

- Motor rotation direction
- LUX brightness
- Volume

6.3.2 Change the direction of motor rotation

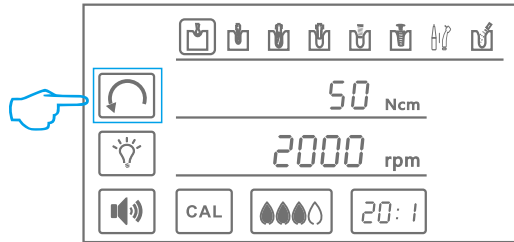

- ▶ Touch the arrow location icon, the motor can switch between forward and reverse;

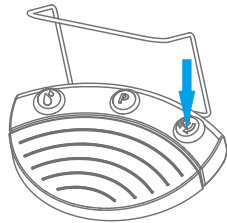

- ▶ The direction of motor rotation can be changed during the treatment using the direction of motor rotation key of the foot control. The changed direction of motor rotation is shown on the display;
- ▶ For safety reasons, running in counterclockwise direction is not saved.

6.7 Calibration

The calibration automatically compensates for torque deviations of the motor that may be caused, e.g., by aging processes. When the handpiece is attached, the unit detects if the handpiece runs sluggish or is defective. The calibration thus provides for a more accurate torque on the contra-angle handpiece.

Note

The handpiece must be attached for calibration.

Calibration should be carried out only with a transmission ratio of 20:1 contra angle.

- ▶ The calibration cannot be carried out with different transmission ratios.
- ▶ The calibration must be repeated whenever the handpiece is changed.

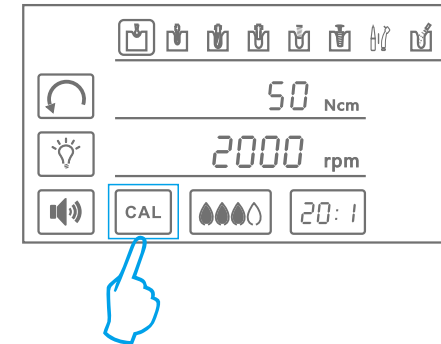

- ▶ Press and hold the arrow location icon until the icon flashes;
- ▶ Motor starts and calibration process automatically executed;
- ▶ After the calibration is completed, resume the standby state. If the calibration fails, an error code is displayed. See "**8. Troubleshooting**" for the corresponding error codes and solutions.

CAUTION

The motor will run automatically during calibration without depressing the pedal.

- ▶ Do not touch rotating parts otherwise there is danger of injury.

6.6 Factory settings

“Factory settings” can be used to reset the unit to its condition at the time of delivery.

- ▶ All programs and device settings are reset to their default values.

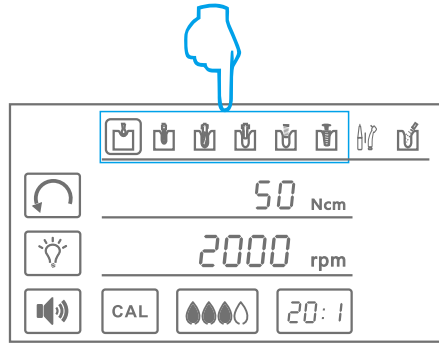

- ▶ Press and hold the program icon that need to be reset until the Icon flashes and buzzer beep twice to indicate the reset has been completed.

6.3.3 Set the LUX brightness

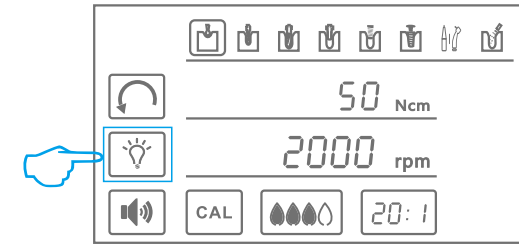

- ▶ The LUX brightness determines the brightness of the LEDs on the handpiece, the brightness can be set in 3 steps ranging from off to maximal brightness.
- ▶ Touch the arrow location icon to change the LUX brightness.
- ▶ Changed values are saved automatically and are then available for the next use.

6.3.4 Set the volume

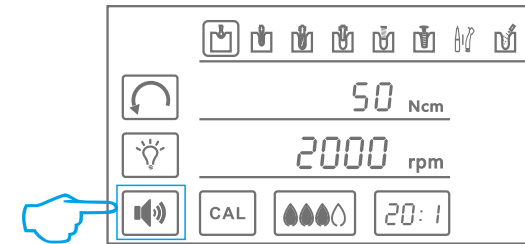

- ▶ The volume level determines the volume of signal sounds, the volume can be set in 4 steps ranging from quiet to maximal volume.
- ▶ Touch the arrow location icon to change the volume.
- ▶ Changed values are saved automatically and are then available for the next use.

6.4 Changing default values

6.4.1 The following default values can be changed within the specified range

- Maximal speed
- Torque limit
- Coolant flow
- Transmission ratio

i Note

The value of each program can be changed, select the appropriate program, then change the value.

6.4.2 Set the maximum speed

- ▶ Touch the arrow location until the speed value flashes, at the same time, the adjustment key appears on the right side of the screen.

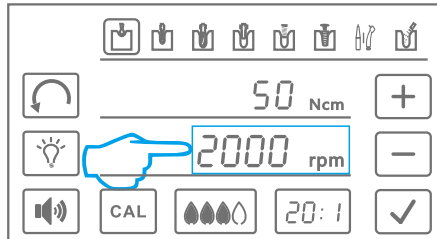

- ▶ Press the plus and minus keys concurrently to change the selected setting.
- ▶ Press the “√” key to save the value.

i Note

To adjust or set the motor parameters, please see: “6.3 Setting” and “6.4 Changing default values”.

6.5.3 Rinsing function

The rinsing function serves to feed liquid and to start-up the illumination on the handpiece.

The motor is not activated during this process.

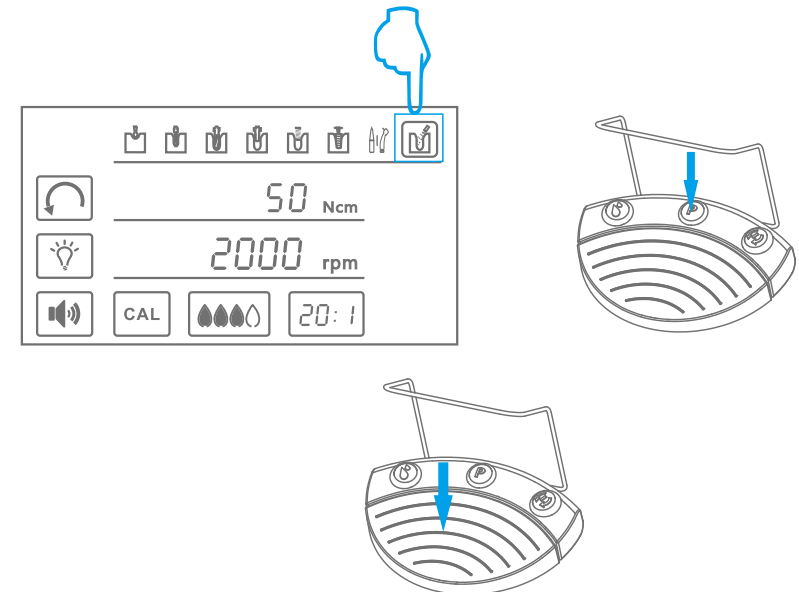

- ▶ Touch the coolant display until the supply rate is set as desired;
- ▶ Touch the screen to select rinsing program, the program can also be selected by the program key of the foot control;
- ▶ Press the pedal, the coolant is supplied at the set flow rate;
- ▶ When the motor is running, the LEDs illuminate according to the set brightness;
- ▶ Release the pedal, the coolant flow stops.

6.5.2 Free use

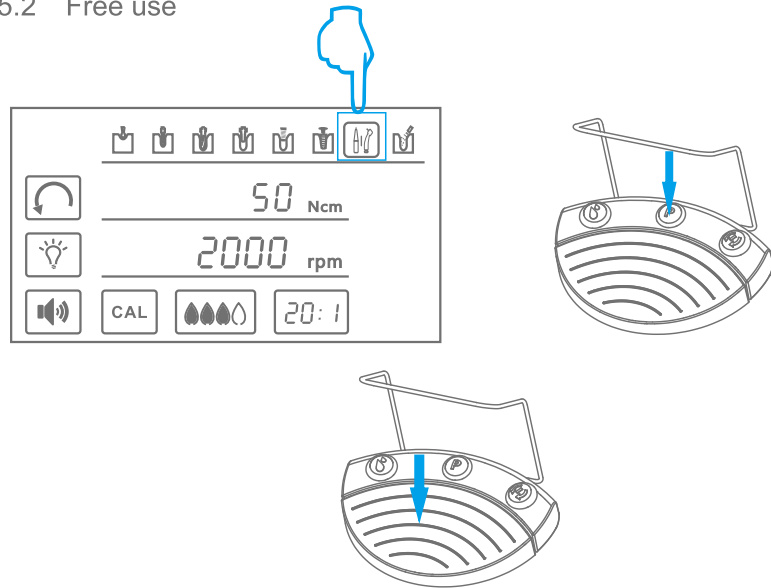

i Note

The user can add other programs to the free use. In addition to the planting procedure, it can be used as a dental treatment such as surgery or polishing.

In the activity, "Free use", all available values can be set.

- ▶ Touch the screen to select free use program, the program can also be selected by the program key of the foot control;
- ▶ Select the direction of the motor rotation;
- ▶ Press the pedal, the motor runs in accordance with the set direction;
- ▶ The speed of the motor depends on the pressure of the pedal. When the pedal is pressed to the end, the motor rotates at the maximum speed set;
- ▶ When the motor reaches the programmed torque limit, it stops automatically;
- ▶ When the motor is running, the coolant is supplied at the set flow rate;
- ▶ When the motor is running, the LEDs illuminates according to the set brightness;
- ▶ Release the pedal, the motor and coolant flow stop, and the LEDs turn off.

6.4.3 Set the torque limit

i Note

The Device reduces the power to prevent the maximal torque setting from being exceeded. This may lead to the motor coming to a standstill if the rotating handpiece is blocked.

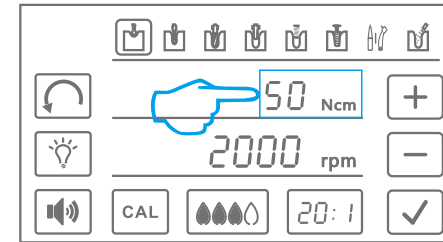

- ▶ Touch the arrow location until the torque value flashes, at the same time, the adjustment key appears on the right side of the screen.
- ▶ Press the plus and minus keys concurrently to change the selected setting.
- ▶ Press the ✓ key to save the value.

6.4.4 Set the coolant flow

! CAUTION

Coolant dosed incorrectly.

Tissue damage.

- ▶ Please note the instructions for use of the attachment tool.
- ▶ Set the coolant flow sufficiently high.

The coolant flow rate can be set to 4 levels or switched off

- : Off
- : 60 ml/min
- : 85 ml/min
- : 110 ml/min
- : 135 ml/min

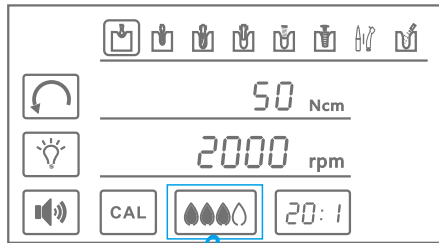

- ▶ Touch the coolant display until the supply rate is set as desired;

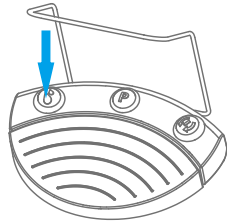

- ▶ The coolant flow can be set during the treatment using the pump key of the foot control;
- ▶ The changed value is shown on the display.

6.4.5 Set the transmission ratio

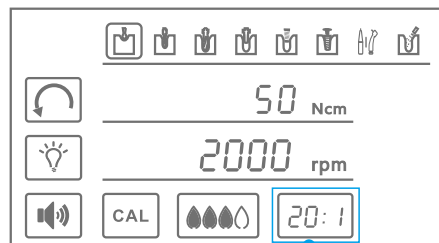

- ▶ Touch the transmission ratio display to set the value as desired.
- ▶ Changed values are saved automatically and are then available for the next use.

6.5 Operation

6.5.1 Surgical programs

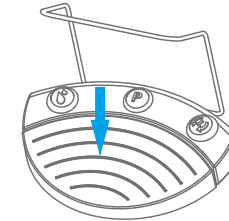
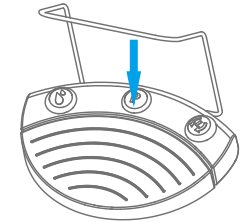
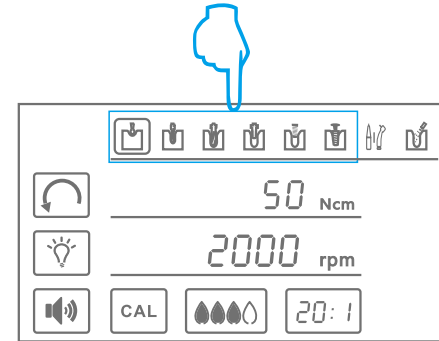

- ▶ Touch the screen to select implant program desired, the program can also be selected by the program key of the foot control;
- ▶ Select the direction of the motor rotation;
- ▶ Press the pedal, the motor runs in accordance with the set direction;
- ▶ The speed of the motor depends on the pressure of the pedal. When the pedal is pressed to the end, the motor rotates at the maximum speed set;
- ▶ When the motor reaches the programmed torque limit, it stops automatically;
- ▶ When the motor is running, the coolant is supplied at the set flow rate;
- ▶ When the motor is running, the LEDs illuminates according to the set brightness;
- ▶ Release the pedal, the motor and coolant flow stop, and the LEDs turn off.

i Note

To adjust or set the motor parameters, please see: “6.3 Setting” and “6.4 Changing default values”.